

**GOVERNMENT OF INDIA
MINISTRY OF RAILWAYS
RAILWAY BOARD**

No. 96/RE/141/8 Pt. I

New Delhi, Dated: 21.10.2011

CSTE/CORE
Allahabad

Sub: Guidelines from DOT for REPC Clearance

Ref: DOT Letter No. 8-4/2009-SI (Pt. I) dated: 30.09.2011.

Please find enclosed herewith the latest guidelines and regulations for obtaining REPC Clearance from DOT. This is for your information & necessary action.

DA: As above.

21/10/2011
(Aruna Singh)
EDRE (S&T)

N.O.O.

Director/Tele for posting it as telecom guidelines from DOT for taking REPC Clearance.

Government of India
Ministry of Communications & IT
Department Of Telecommunications
(Security -TERM Wing)
Sanchar Bhavan, 20-Ashoka Road, New Delhi-110001

No. 8-4/2009-S1 (Pt. I)

Dated: 30th Sept, 2011

Sub: Electromagnetic Compatibility Compliance Enforcement and Regulation of telecom and railway operator regarding.

With the growth of the Telecom and Railways a need was realized by the Government to have an organization under DOT to coordinate, regulate and enforce basic principles of electromagnetic compatibility compliance wherever railway electrification being commissioned.

2. The railway electrification coordination, regulation and enforcement work which was being taken care by BSNL after carving of BSNL out of DoT has now been taken back by DOT from BSNL and placed under Deputy Director General, Telecom Enforcement Resource and Monitoring, Delhi. The general guidelines with respect to said organization in the perspective of public safety and in the national interest have been formulated and termed as 'General guidelines in respect of procedure on Electromagnetic Compatibility Compliance Enforcement and Certification with respect to telecom consumers in India'. The guidelines are enclosed with this letter for further action by all concerned for the common good of the telecom users in the country.

30/09/11
(Pradeep Kumar)
Director (Security -I)

To

1. ED(Railway Electrification-S&T) Rail Bhavan, New Delhi.
2. DDG, TERM Cell Delhi
3. All DDG TERM Cells
4. All CCAs
5. All Telecom Operators
6. Dir(IT), DoT for uploading on DoT website

Ver 1 Dated 30th Sept' 2011

Government of India
Ministry of Communications & IT
Department Of Telecommunications

General guidelines in respect of procedure on
Electromagnetic Compatibility Compliance
Enforcement and Certification in respect of
induction affecting telecom from electrified
Railway tracks

Issued by: Security-TERM Wing, DoT

Ver 1 Dated 30th Sept' 2011

Chapter-1

Preliminary

Short title and commencement:

(1) These guidelines are called as the 'General guidelines in respect of procedure on Electromagnetic Compatibility Compliance Enforcement and Certification in respect of induction affecting telecom from electrified railway tracks'.

(2) These guidelines shall come in to force from the date of issue.

Definitions:

1. **Induction zone:** The zone where the telecom circuits /installations lines and personnel are exposed to the EMF being emitted from railway catenaries, equipments in the electrified sections.
2. **Telecom operator:** Any licensed telecom operator operating under a license from Central Government .
3. **Railway operator/ Agency:** Any agency under taking Railway electrification works with in India
4. **EMC or Electro Magnetic Compatibility:** It is the ability of electronic /electric apparatus to operate in its intended environment without suffering unacceptable degradation or causing un-intentional degradation to other apparatus or danger to the human being.
5. **Induction Voltage (IV):** Induction voltage is the value of induced voltage along the length of telecommunication lines with respect to the earth due to induction of EMF emitted from electrified railway tracks.

CHAPTER-2

Technical information on EMF effect due to electrification and affected networks

The telecom installations existing close to the railway tracks which are proposed to be converted to high voltage traction would be subjected to electromagnetic induction effects. The over head catenary (pantograph and contact wire) of the traction system is at a high voltage (25000V and may vary based on the technologies adopted by the concerned railway systems) with reference to earth and as a result an electric field is produced in the vicinity of the catenary. The neighboring telecommunications wires, cables, other telecommunication installations situated within this field get charged to high potentials with respect to earth, thereby causing danger to the equipment and working personnel and also interference to the telecommunication circuits.

2.2 In general, interference from a power line to a neighboring telephone line can arise mainly by magnetic induction when current flows, electrostatic induction from line voltage, Resistive coupling via earth electrodes.

- (i). **Electric Induction:** This is due to capacitive coupling between the power line and telephone line and is normally more affective in overhead circuits

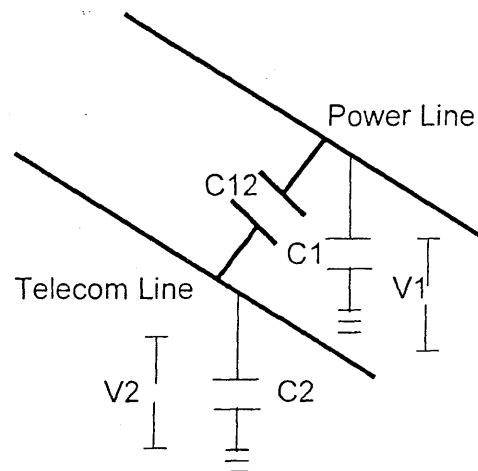

Figure (1)

$$V2 = \left[\frac{C12}{(C12+C2)} \right] \times V1$$

C12 is Capacitance between two wires, C2 is Capacitance to earth of telephone wire. V2 therefore depends on voltage of power line and telephone line and earth. Induced voltages of some 400 V have been experienced from 11 KV power lines. As the length of parallelism increases the effective capacitance also increases. When the length exceeds about half a mile a distinct shock can be experienced on touching a contact with telecom lines.

- (ii) **Electro magnetic induction:** The main difficulties likely to arise will be from electromagnetic induction due to the magnetic fields produced by traction currents linking with the Telephone circuits and inducing longitudinal voltage.

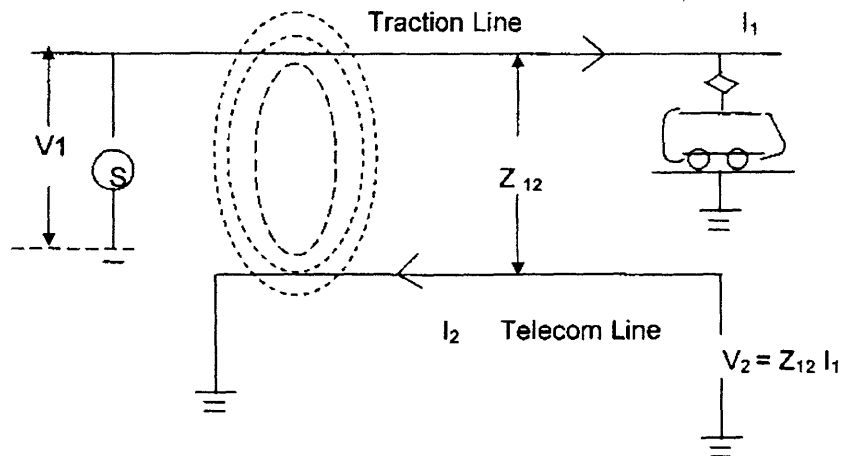

Figure (2)

The Longitudinal voltage V_2 is an induced voltage on the telephone line. $V_2 = -j\omega MI_1$; where M is mutual inductance between two lines, $j\omega = 2\pi f$ and I_1 is the current in the traction. Such voltages are thus directly proportional to current in traction system and to the mutual inductance between traction line and telephone line. Please see figure (2). The rectifiers on the trains and the traction will result an event containing a large number of odd Harmonics. To some extent the magnitude of harmonics depends on the degree of smoothing introduced.

- (iii) **Resistive coupling via earth:** The current, which is discharged to the rails from a Train leaks away to earth and a potential gradient, therefore exists in the surrounding earth. If a telecommunication earth exists in the vicinity, it assumes the same potential relative to remote earth as exists in the ground in which it is buried. Hence there is the possibility that cables crossing Railway may acquire such a potential. Please see figure (3).

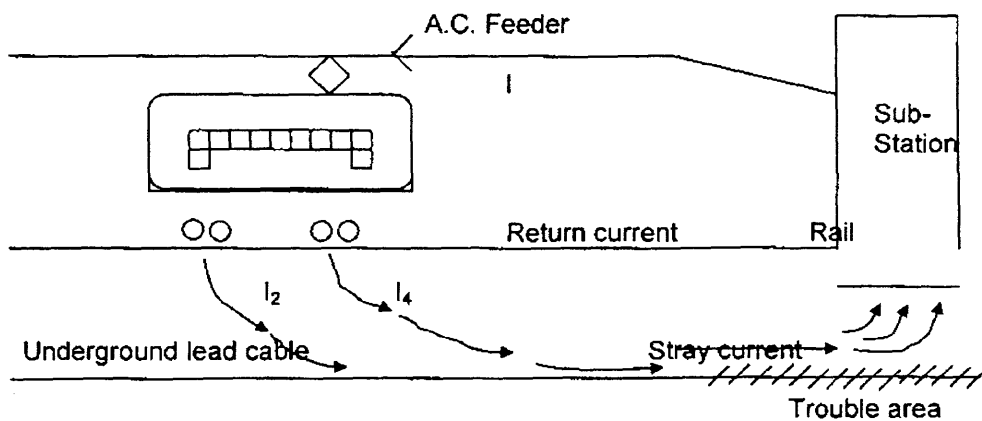

Figure (3)

2.3 Effect on Telecom communication circuits due to :

(i) Longitudinal Voltages:

It has been seen that longitudinal voltages will be induced electro magnetically in neighboring telephone lines both at fundamental frequency of 50 c/s and various harmonic frequencies.

In the absence of suppression at source, induced voltages between 2V - 60V could be expected, the most commonly occurring value being about 30 V. This is below the CCITT limit of 60 V laid down to avoid danger to personnel, but is liable to interfere seriously with DC signaling over junctions and data circuits.

The Telephone system has developed gradually over the last 50 years or so. Basically about 20 different designs of exchanges using many different vintages of equipment. DC Signaling is used very extensively in junction network. Current developments such as ISD, STD and ADSL, other last mile connecting technologies, INTERNET dialing etc are more vulnerable to the induced voltages. It becomes hurdle especially in maintaining the quality of service standards.

The lowest values of induced (50 c/s) voltages cause functional interference, varying for different designs of termination. As the interfering voltages increase, the differences between lengths of the individual pulses become increasingly pronounced. If such junctions are there in a multi link connection approaching the permitted limits of distortion, there would be an increasing number of failures with increase in the induced voltage. At higher induced voltages, the pulses are split and would cause trouble on all call routings. Please see fig (4) where the observation of loop/ disconnect pulses distortion under the influence of 50 c/s induction is depicted.

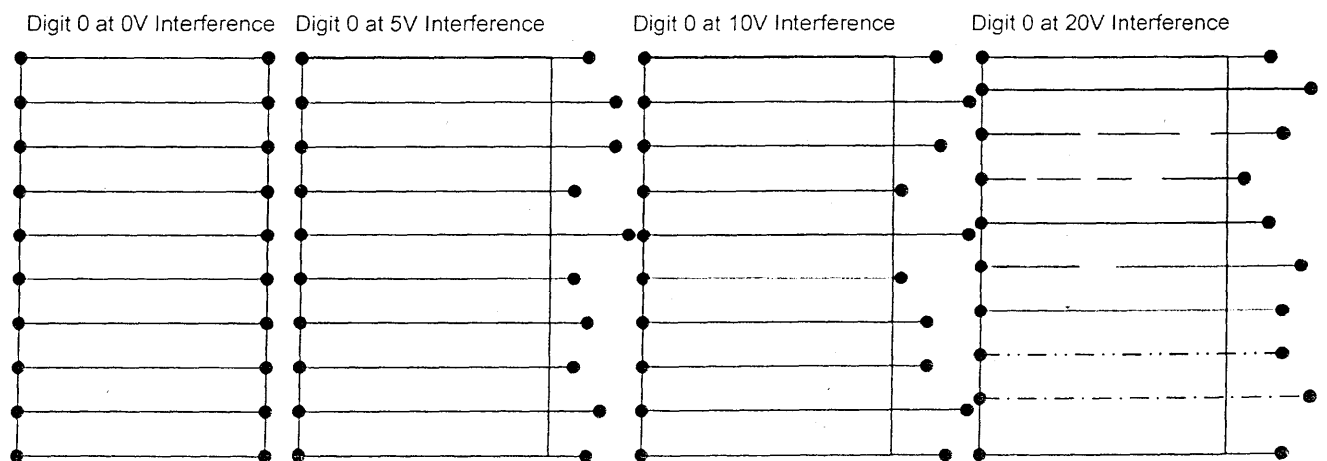

Figure-4

(ii) **Transverse voltages:**

Railways Electrification will also induce transverse voltages in neighboring telephone lines, which are detrimental to the quality of telephone services. The following network elements are likely to be affected.

- Lines and cables branching off or jointing at various junction points.
- Lines and cables at certain places where they cross or run parallel to the catenary for a length.
- Local land line, telephone subscribers network junction, cables tie
- Short distance PCO lines Local telegraph circuits and leased circuits which are of conductor.
- Any Exchange, RLU, BSU, and their leading in cables locate close to the railway track.
- Track crossings which may be parallel to the track. etc.
- Any data cable, co-axial cables, ISDN or data circuits which are extended on the metallic conductor pair to the premises etc.

2.4 Interference with video television circuits: Television signals are generally transmitted over co-axial cable pairs. The signals may be transmitted in the video band of 0-3 mega c/s or even on higher frequencies using carrier techniques. Signals in video frequency range are very sensitive to 50 c/s induction effects. If the induced voltage (50 cycles/ sec) exceeds approximately 2.5 V, video frequency transmission becomes impossible and frequency translating equipment may be needed to improve quality. The provision of such equipment adds greatly to the overall cost of circuits.

Chapter-3

Corrective measures and methods being used for protection

The corrective measures in protection mechanism for saving personnel and telecom infrastructure from dangerous induction voltages which are in vogue in the industry as on date are described below. Any how the day to day application in the field can be obtained from the concerned ADG (RE), which are dependent on the geographical conditions, telecom and railway technologies used in the respective systems. It is obvious that high voltages, likely to be induced in the telecommunication network within the zone of influence of the electric catenary are likely to exceed the safe limits set by ITU for the safety of equipment and human personnel. Suitable remedial measures to mitigate the effect of hazardous induced voltage are therefore necessary. The following protection arrangements are identified practices in vogue.

2. Measures for adsorption at the source i.e. on the AC traction line.
 - i) Use of Autotransformers & Booster transformer (please refer to glossary in chapter-5 and Fig (5)).
 - ii) Parallel operation of traction substations.
 - iii) Rail Bonding Practices etc.
3. Measures for adsorption on affected telecom lines.
 - i) Laying of screening wires over the long distance telecom and co-axial cables.
 - ii) Use of Aluminum sheathed and steel tape armored co-axial and LD telecom cable
 - iii) Use of special types of co-axial cables with higher dielectric strength.
 - iv) Use of high isolation in co-axial cable systems.
 - v) Use of separate power feeding cables for co-axial systems.
 - vi) Use of VHF Radio links for rural PCO's provided on over head/Open line wires
 - vii) Provision of Active reduction system on local telephone cables.
 - viii) Use of Gas discharge tubes
 - ix) Use of Optical Fiber Cable System without armor
 - x) Use of domestic satellite communication links.
- 4 Further, following measures are also recommended.
 - 4.1 No over head alignments should exist within 50 meters from the railway track in electrified section to avoid static charging by higher working voltages.
 - 4.2 GUIDELINES FOR PROVIDING BOOSTER TRANSFORMERS AND RETURN CONDUCTORS: (ref 114/2/92/TPL(CX) DATED 17TH MAY, 1994)
 - a) The voltages on DOT lines due to Railway electrification should not exceed 60 V longitudinal voltages and 5 V as transverse voltage in normal working conditions and 430 V under faulty condition (as per CCITT recommendations).

- b) Railway Reduction Factor for the new schemes i.e. coming after cutoff date of 17.05.94, can be taken as 0.28 where all the four rails are conducting under the following conditions:-
 - i) The Rails have been provided with bonded joints and not mechanical joints.
 - ii) After the Railway Electrification work is completed, if on actual measurements the RRF is not more than 0.28,

In all other cases the RRF is taken as 0.44.
- c) As per letter no 114/2/92/tpl(cx) dated 17th May, 1994 it was also clarified that railway will provide the protective equipments only for the existing installations and not for future installations.

Chapter -4

Procedure to be followed for protection work

Consequent to the decision of Telecom Commission to undertake the enforcement and regulatory works in connection with the railway electrification protective works and matter related to equipment and public safety, the following guidelines are being circulated hereby for adherence and compliance by the telecom operators. The powers and functions of REP Cell O/o DDG(TERM) New Delhi shall broadly be as follows:

- i. Enforcing protection of Telecom circuits / installation / Lines and personnel falling under induction zones.
- ii. Inspection of protective works completed by Telecom operators on sample basis.
- iii. Co-ordination & Liaison with various Railway authorities / agencies, PTTC, DOT & BSNL / MTNL.
- iv. Technical study & Tests on new technologies being inducted by Rail & Telecom operators from induction voltage perspective.
- v. Joint Vetting of the estimates of service providers and further submission to railway
- vi. Reconciliation of Railway payments & Completion Reports.
- vii. Joint inspection along the electrified Rail track to ensure the quality of Rail earthing / bonding, presence of Booster Transformer Return Conductor (BTRC) as per requirement.
- viii. Issue of clearance of electrified rail track to Commissioner Railway Safety.
- ix. Settlement of related disputes between rail and telecom operators.
- x. Preparing Guidelines for assessing Induction Voltage (IV) & BTRC requirements for Telecom operator & Railways / Agencies.

(2) Subject to the provisions of Indian Telegraph Act, it shall be the duty of the DOT to enforce licensee for protection of telecommunication circuits, equipment, personnel, and mitigate the EMF effect that would emit from the railway catenary etc.

(2A) Without prejudice to the generality of the foregoing provisions contained in subsection (1) i to x of chapter 4 of these guidelines, and sec 5 (1), sec 7 (e) (g) (k), sec 19A, and 25A of Indian telegraph act 1885, the Telecom Authority may take measures to undertake issuing guidelines, regulate, enforce, inspect regarding the procedure for telecom operators and railways taking up protective works and protection of Telecom circuits / installation / Lines and personnel falling under induction zones and subsequently issue clearance certificate to the concerned agencies.

(3) The established existing procedure for telecom operators and railways for taking up protective works and protection of Telecom circuits / installation / Lines and personnel falling under induction zones shall be as follows:

(3A) Guidelines/ obligations to the telecom operators:

- 1 Railways places firm demand in the prescribed pro forma along with other details as per existing practices to designated DOT officer / ADG(RE) in the respective jurisdictions
2. The designated ADG (RE) shall communicate to operators and calls for the necessary information in the required Pro forma as broadly mentioned here in the following points.

- i. Telecom network details in the vicinity of railway track of the section proposed for electrification.
- ii. Distance between track and telecom installations including the copper cable etc...
- iii. Earth resistance in vicinity of the track.
- iv. Number of railway crossings and their diagrams including the pipe details and angle of cross section
- v. Existing over head crossings and their locations
- vi. Un-dismantled over head alignments or posts in the vicinity of the proposed track.
- vii. The position of the railway circuits being owned or maintained by the telecom operator.
- viii. Any other telecom installations like Towers, RLU, BSU, Pillars, and Posts etc.
- ix. Any other related information as and when required for the concerned officer.

The above information should be marked on a 1:125 scale GSI maps

3. This information should be submitted to designate ADG(RE) within the prescribed time limit, generally fifteen days after receipt of said communication, may be extended based on the field conditions and discretion of DOT.

4. ADG(RE) shall conduct sample inspections and submit Induction Voltage calculations and BTRC requirement to railways. The protection and re arrangements suggestion shall be communicated to telecom operator. The EMF mitigation plan should be submitted to the DOT in accordance with the instructions issued by ITU and DOT from time to time. These plans can be modified in actual execution in consent with the ADG to fit with local condition but the public safety should be the utmost concern. While preparing the protection plans care should be taken to meet the equipment and public safety in most economical way to avoid unnecessary spending of national wealth, and should have a reasonable judgment within the ordinary prudence.

5. The operator should prepare estimates for protection/re-engineering and submit to concerned DOT officer for further inspections, scrutiny and vetting the same, and forwarding to the railways with recommendations for payment, if the protection /re-engineering schemes are coming within the purview of EMF mitigation obligation of Railway operator. Notwithstanding to the generality of this obligation of railways, the telecom operator also have an obligation to conduct the smooth operations of telecom services as per the licensing terms, conditions and TRAI regulations on quality of service and in interest of public safety. The obligations on meeting the expenses of the operator for re-engineering are based on the different agreements arrived between DOT and Railways from time to time. If any protective work not covered under such obligations and if the railway operator or agency has complied with the sec 19 A (1) shall have the provision given in sec 25 A Para (2) of Indian telegraph act.

6. The concerned telecom operator should execute the finalized scheme within the prescribed time as agreed in consent with the railway and DOT officers to meet the targets of the projects of national importance. After completion of the works a certificate of completion should be submitted as compliance to the concern of public safety and for effecting the payment if covered in the obligations of railway. Concerned DOT officer may under take sample checks of the protective works before issue of clearance to concerned railway authorities.

7. Concerned DOT officer will scrutinize the estimates based on the agreements, consultations, reasonableness and other guidelines as and when applicable from time to time. The inclusive estimates covering all costs of DOT shall be submitted to railways after vetting for effecting payment by the railway agencies/operator and agency shall be advised to effect proportionate payment directly as per mutual convenience.

(3B)

1. Information to be submitted (in the prescribed proforma) by the railway operator/agencies to the concerned DOT officer along with the firm demand:
 - i. Railway network diagram of the proposed section along with chain age
 - ii. Proposed Transformer Sub Station (TSS) location
 - iii. Proposed Sub Section paralleling Post (SSP)
 - iv. Catenary's current
 - v. Transformer ratings in the sub stations
 - vi. All relevant electrical diagrams
 - vii. Track circuit locations and technology of the track circuits.
 - viii. Existing block circuits if they are on lease from BSNL/MTNL or any other operator
 - ix. Location and length of tunnels, if any, planned in the section.
 - x. Slope of the section, if any gradient in level of the track.
 - xi. Any other item as asked by the DOT officer in prescribed pro forma.
2. After conducting the joint inspections the Induction Voltage calculations and BTRC requirements shall be given to railway by DOT officer on the basis of the information submitted by both telecom and railway operator.
3. Subsequently DOT shall submit the consolidated inclusive estimates in the existing pro forma for processing and effecting the payment.
4. Railways and telecom operators have to submit the certificate to the effect that of all obligations have been met with as decided by both the parties and as per the guidance of concerned ADG (RE) DOT from respective sides.

DOT officers shall undertake the sample checks and issue clearances to the concern authorities.

CHAPTER -5

Meetings and Miscellaneous

(A) Meetings:

Meaningful meetings and reasonable dialogue can create right dispensation of any problem. In the present scenario when every sector is booming in India there should be meaningful coordination at appropriate levels in both sectors to avoid any mishap or unprecedented Incidentals. Therefore the following meetings of co-ordination committees shall be conducted at regular intervals which are the highest dispute resolution bodies at implementation level.

1. Field meetings:

These meetings shall be convened by the concerned ADG in his jurisdiction as per the requirement of field offices to monitor the progress of the works etc. It should be conducted as frequent as possible to achieve the goals. Any higher officer can also attend these meetings If desired so by railway agency.

2. Project level meetings:

These meetings shall be conducted between the respective operators/agencies to understand guidelines and to implement the policies at project level. The frequency of these meetings shall be once in two months. Director (RE) may conduct at the convenient place and time of all the stake holders of that particular project to educate, sensitize the importance of the public safety in these projects. In these meetings the agenda of the all stake holders should be taken up and deliberate in the Interest of nation and public safety. Any unresolved issue should be referred to operator level meetings for final decision

3 Operator level meetings:

Director (RE) shall convene this meeting under the chairmanship of DOT Senior Officers once and Railways Senior Officers next time alternatively. The frequency of this meeting shall be at least once in every year. The representatives of the operators of both the sectors shall be members in this body. This body shall follow up the items of board level meetings with the respective ministries.

(B) Miscellaneous:

1. In the event of any question, dispute or differences arising within the purview of these guidelines or in connection thereof, except as to the matter, the decision of which is specifically provided elsewhere under any law thereof, an aggrieved party can appeal to DDG (TERM) Delhi (Appellate authority) along with an application for resolution. Appeal shall be entertained only if the matter is not settled in the bilateral meetings. After admitting the issue, matter may be enquired on his own accord or through any of his representative. Appellate authority shall entertain only if the application is filed within one month from the date of meeting in which matter is declared unsettled. If matter is related to the policy framing and is not in the purview of the authority it can be referred to Inter-Ministerial Meetings (Board Level Meetings) and DOT for framing further required policy. The either parties have always have provision to approach courts of law in the event of dissatisfaction over the authority's decision.

II. Without prejudice to the provisions contained in any of these guidelines, any other law thereof, DOT is empowered to impose penalties as under sec7 (e) (g) (k), 25A and as decided by the telecom authority from time to time for willful negligence or non compliance to the safety norms and subject matter guidelines issued by DOT from time to time. DOT RE wing shall act as dispute resolution body between telecom operators and Railways in the concerned subject matter as per the provision given in the subsection (1) vi and ix of chapter 4 of these guidelines. Accordingly Director (RE) New Delhi shall act as adjudicator in the event of dispute between Railways and telecom operators. Any incidentals due to negligence of the operator in taking due diligent action within the ordinary prudence of the concerned operator's representative in taking up the protection mechanism within the stipulated time shall be the sole responsibility of the operator only.

III. Notwithstanding anything contained in these guidelines and anything thereof DOT may change, modify partially or fully the guidelines based on the technological development and other considerations in the interest of public safety and for effective use of telecommunication services.

Chapter-6

Glossary

Pantograph

To begin with, the electric railway needs a power supply that the trains can access at all times. It must be safe, economical, user and environmental friendly. It can use either DC or AC. AC systems always use overhead wires, DC can use either an overhead wire or a third rail; both are common. Both overhead systems require at least one collector attached to the train so it can always be in contact with the power. Overhead current collectors use a "pantograph". The return circuit is via the running rails back to the substation. The running rails are at earth potential and are connected to the substation.

Catenary & Return Conductor

AC Overhead lines are normally fed by 25,000 volts in sections which are usually much longer than in DC. In order to complete circuit, from the source of the energy up to the consuming item (light bulb, cooking stove or train) and back to the source, a return conductor is needed for the railway system. Railways generally use the steel rails as return conductor where the wheels run on.

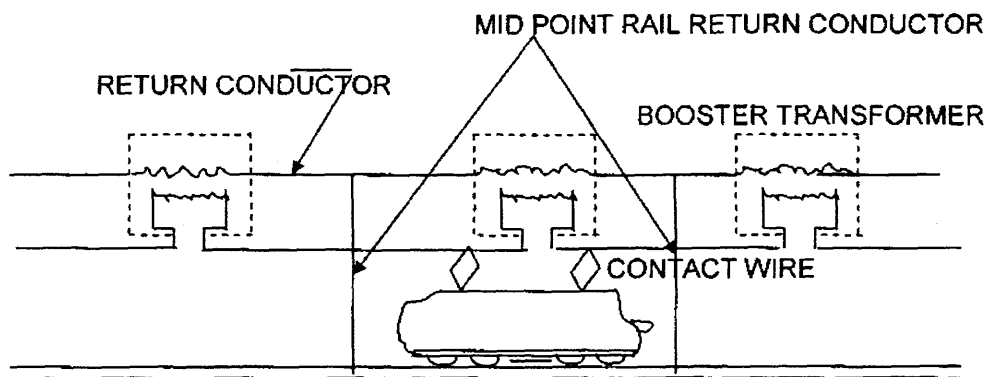

Figure (5)

Booster Transformer with return Conductor

Booster Transformers

If a communication cable is laid alongside rails carrying the return current of the overhead line supply, it can have unequal voltages induced in it. Over long distances the unequal voltages can represent a safety hazard. To overcome this problem, booster transformers with return conductors are provided. These are positioned on masts at intervals along the route and are connected to the feeder station by a return conductor cable. The return conductor is connected to the running rail at intervals parallel to the rails. The effect of this arrangement is to reduce the noise levels in the communications cable and ensure the voltages remain at a safe level. Please see figure (5).

ANNEX

FREEQUENTLY ASKED QUESTIONS

Q1 What is Booster transformer and return conductor (BTRC)?

(A) Booster transformer is a transformer connected on to an AC Railway system to ensure that high proportion of return current will flow to the earth at substation through the rails or through a specially provided return conductor.

Q2. What is rail return factor (RRF)?

(A) RRF is the ratio of actual induced voltage on telecom circuits in the presence of conducting tracks to the value of induced voltage in the absence of conducting tracks

Q3. What is the induction Voltage?

(A) Induction voltage is the value of induced voltage along the length of telecommunication lines with respect to the earth due to induction of EMF emitted from electrified railway tracks.

Q4. What is EMC?

(A) EMC or Electromagnetic Compatibility is the ability of the electronic/electric apparatus to operate in its intended environment without suffering unacceptable degradation or causing un-intentional degradation to other apparatus. The requirements for the control of EMC are embodied in the European EMC Directive, 89/336/EEC, which became mandatory from 01.01.1996. The directive applies to all electrical and electronic apparatus, including that operating in the Railway environment. EMC is an important aspect in Railway Systems providing for safe and reliable operation and as such EMC forms part of safety case.

Q5. What are Autotransformers?

(A) The electric energy for railways is supplied in high voltage to catenary feeder substations, where the voltage is reduced to a suitable level and fed to the railway catenary conductors to be used by locomotives and trains.

Catenary autotransformers are used in modern high-power railway catenary systems fed with two phases with a 180° phase shift, with the mid-point connected to the earth. They are applied to all new high-speed train systems. The advantages that are obtained with this connection compared with booster transformers are among the following, depending on the objectives:

- Lower losses due to higher voltage
- Longer distance between catenary feeder substations
- Better collection of returning stray currents
- Reduced interference for communication

Q6. What is the importance of Earthing and Bonding?

(A) Earthing and Bonding is best understood, not as a collection of various items of hardware, but as a 'design process to mitigate the risk of damage to people and property to:

- provide a very high-reliability low impedance return path for normal traction current

- provide a low impedance path for traction fault currents which will result in rapid tripping of controlling circuit breakers, whether caused by damage during normal operations of the overhead traction power system or by acts of deliberate vandalism
- limit readily accessible touch potentials to metalwork or semi-conductive surfaces, such as concrete, during traction fault, however caused
- limit damage to concrete structures which could occur as a result of falling traction supply conductors or accidental or reasonably foreseeable current paths from the traction system, whether caused accidentally or maliciously
- minimize the readily accessible touch potential which can occur between adjacent metalwork
- limit the export of potential, both under normal operation and traction fault, which may have an adverse impact upon railway services within the railway alignment and/or adjacent third party service providers e.g telecommunications, power, water and gas utilities

Q7. What is Electrostatic Potential Difference ?

(A) An energized overhead power line that carries current produces an electric field and a magnetic field around the conductor and into the surrounding spaces. These electromagnetic fields may induce voltages and currents onto the metallic track rails and other nearby conductors. The electromagnetic fields are non-uniform near the power lines.

In a DC Traction system, the voltage induced in the region near the conductor is time independent except for the noise component and the longer time varying DC load component. The correct term for the DC case is electric potential difference or electrostatic potential difference. In an AC Traction system, the electric and magnetic fields are alternating, as are the induced voltages and currents in the conductors. The correct term for the AC case is electromagnetic field induction or electromagnetic coupling. The Electrostatic Potential Difference is less detrimental than the Electromagnetic Potential Difference.